

(24) NAME \_\_\_\_\_

Find the AREA of each figure.

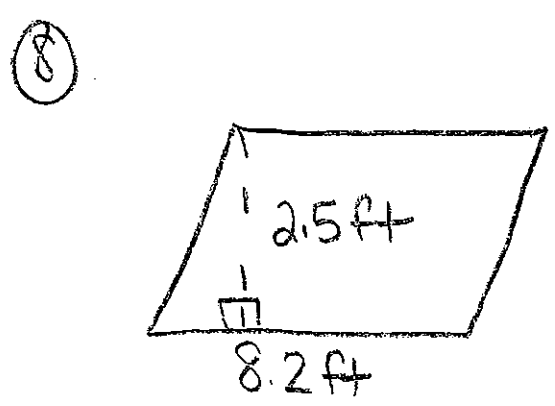

9

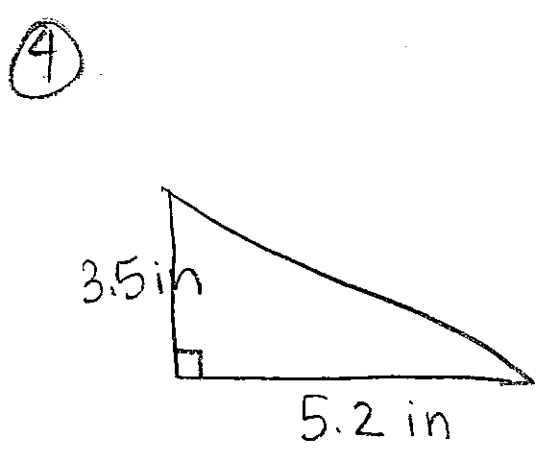
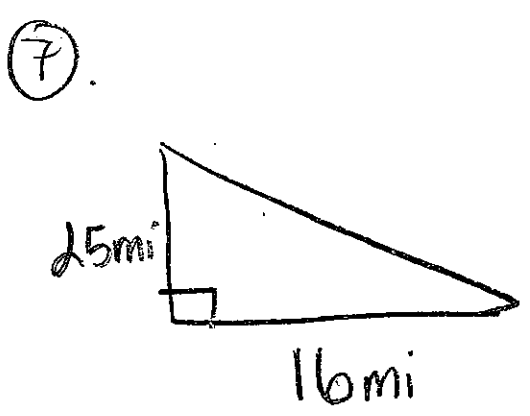
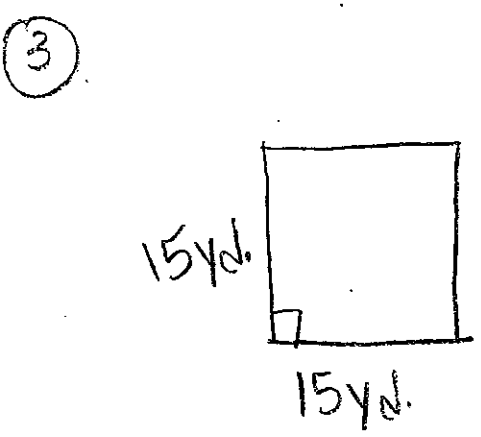
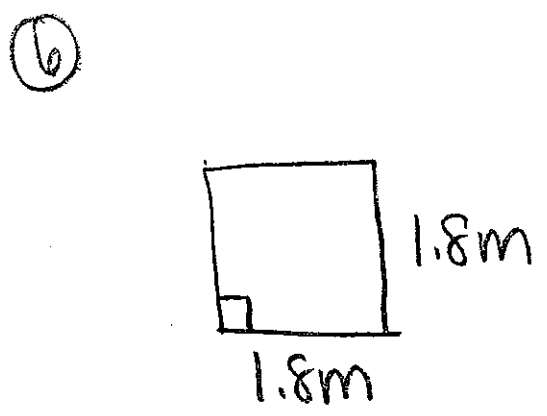
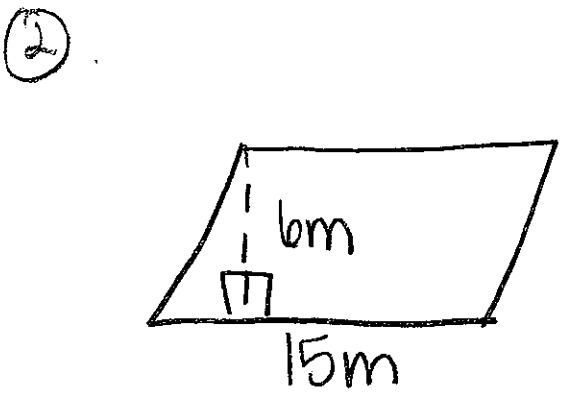
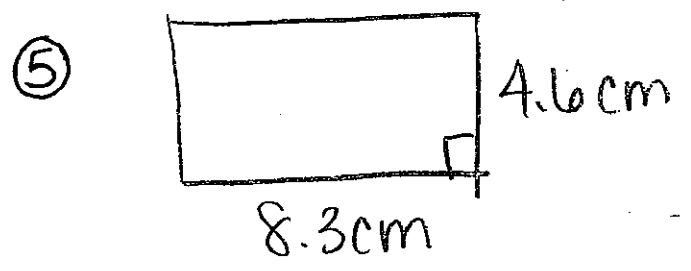
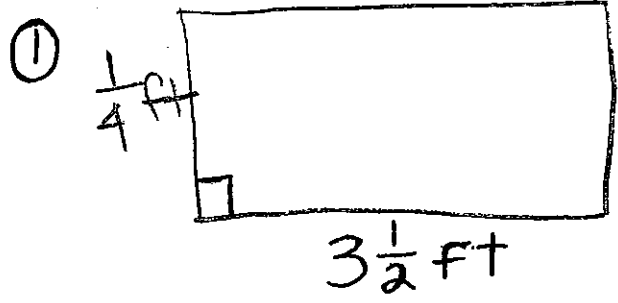
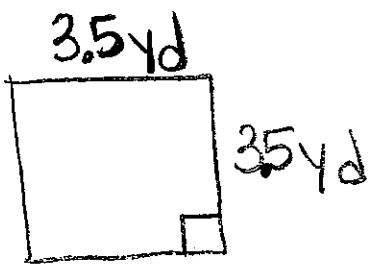

10

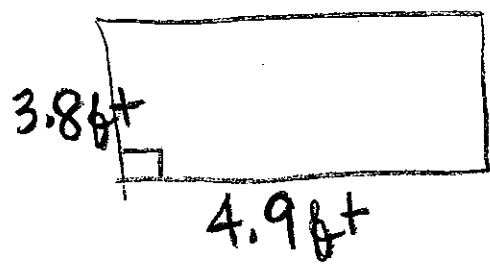

Find the area of each figure.

