

NAME _____

AREA OF IRREGULAR SHAPES

Find the Area of each figure.

①

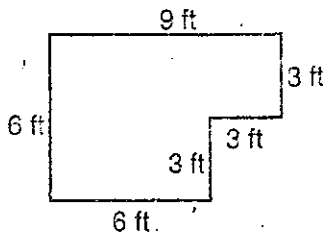

②

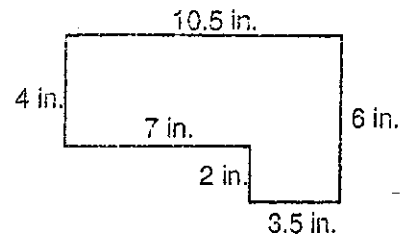

A = _____

A = _____

④

③

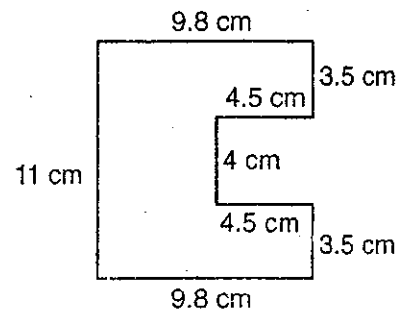
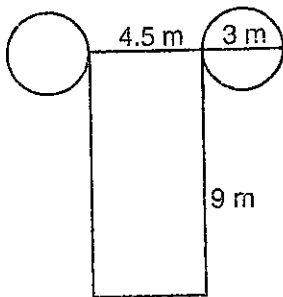

A = _____

A = _____

5.

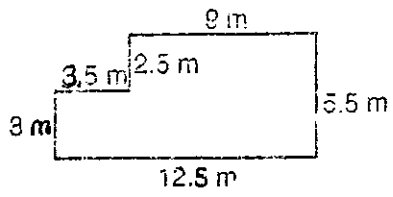

A = _____

6.

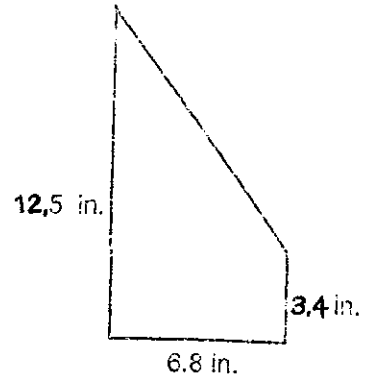

A = _____

7.

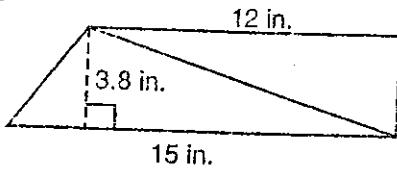

A = _____

8.

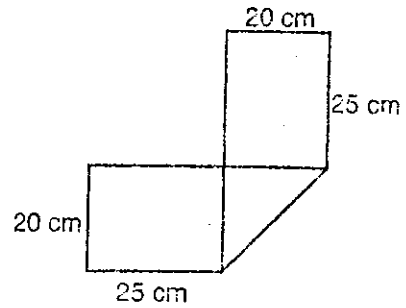

A = _____